

## Surface Mount Transient Voltage Suppressors

### Uni-directional

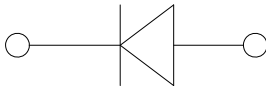
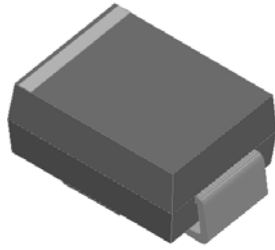

### Features

- Low-profile package
- Ideal for automated placement
- Available in Uni-directional and Bi-directional
- 600 W peak pulse power capability with a 10/1000  $\mu$ s waveform
- Excellent clamping capability
- Low incremental surge resistance
- Very fast response time
- Meets MSL level 1, per J-STD-020, LF maximum peak of 260 °C
- ESD protection of data lines in accordance with IEC 61000-4-2, 30kV(Air),30kV (Contact)
- Part no. with suffix "Q" means AEC-Q101 qualified

### Bi-directional

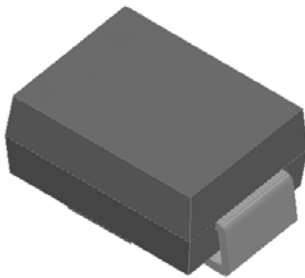

### Typical Applications

For use in sensitive electronics protection against voltage transients induced by inductive load switching and lighting on ICs, MOSFET, signal lines of sensor units for consumer, automotive, and telecommunication.

### Mechanical Data

- **Package:** DO-214AA (SMB)  
Molding compound meets UL 94 V-0 flammability rating, RoHS-compliant, halogen-free
- **Terminals:** Matte tin plated leads, solderable per J-STD-002B and JESD22-B102D
- **Polarity:** For uni-directional types the band denotes cathode end, no marking on bi-directional types

### ■Maximum Ratings (T<sub>a</sub>=25°C Unless otherwise specified)

PARAMETER	SYMBOL	UNIT	Max
Peak power dissipation, with a 10/1000us waveform (1) (2) (Fig.1)	P <sub>PPM</sub>	W	600
Peak pulse current, with a 10/1000us waveform(1)	I <sub>PPM</sub>	A	See Next Table
Peak forward surge current, 8.3 ms single half sine-wave unidirectional only (2)	I <sub>FSM</sub>	A	100
Operating junction and storage temperature range	T <sub>J</sub> , T <sub>STG</sub>	°C	-55 to +150

### ■Electrical Characteristics (T<sub>a</sub>=25°C Unless otherwise specified)

PARAMETER	SYMBOL	UNIT	VALUE
Maximum instantaneous forward voltage @ at 50A for unidirectional only (3)	V <sub>F</sub>	V	3.5



# P6SMB12AQ THRU P6SMB220CAQ

## ■ Thermal Characteristics (T<sub>a</sub>=25°C Unless otherwise specified)

PARAMETER	SYMBOL	UNIT	Conditions	VALUE
Thermal resistance(Typical)	R <sub>θJL</sub>	°C/W	junction to lead	20
	R <sub>θJA</sub>	°C/W	junction to ambient	100

Notes:

- (1) Non-repetitive current pulse, per Fig. 3 and derated above T<sub>A</sub>= 25°C per Fig.2.
- (2) Mounted on 0.2 x 0.2" (5.0 x 5.0 mm) copper pads to each terminal.
- (3) V<sub>F</sub><3.5V for devices of V<sub>BR</sub><190V

## ■ Ordering Information (Example)

PREFERRED P/N	PACKING CODE	UNIT WEIGHT(g)	MINIMUM PACKAGE(pcs)	OUTER CARTON QUANTITY(pcs)	DELIVERY MODE
P6SMB12AQ-P6SMB220CAQ	F1	0.1003	3000	48000	13" reel

## ■ Electrical Characteristics (T<sub>a</sub>=25°C Unless otherwise specified)

Part Number (Uni)	Part Number (Bi)	Breakdown Voltage V <sub>BR</sub> @I <sub>T</sub>			Maximum Reverse Leakage I <sub>R</sub> <sup>(6)</sup> @ V <sub>RWM</sub> (μA)	Working Peak Reverse Voltage V <sub>RWM</sub> (V)	Maximum Reverse Surge Current I <sub>PP</sub> <sup>(5)</sup> (A)	Maximum Clamping Voltage V <sub>c</sub> @ I <sub>PP</sub> (V)
		Min(V)	Max (V)	I <sub>T</sub> <sup>(4)</sup> (mA)				
P6SMB12AQ	P6SMB12CAQ	11.40	12.60	1	5	10.2	35.9	16.7
P6SMB13AQ	P6SMB13CAQ	12.35	13.65	1	5	11.1	33.0	18.2
P6SMB15AQ	P6SMB15CAQ	14.25	15.75	1	1	12.8	28.3	21.2
P6SMB16AQ	P6SMB16CAQ	15.20	16.80	1	1	13.6	26.7	22.5
P6SMB18AQ	P6SMB18CAQ	17.10	18.90	1	1	15.3	23.8	25.2
P6SMB20AQ	P6SMB20CAQ	19.00	21.00	1	1	17.1	21.7	27.7
P6SMB22AQ	P6SMB22CAQ	20.90	23.10	1	1	18.8	19.6	30.6
P6SMB24AQ	P6SMB24CAQ	22.80	25.20	1	1	20.5	18.1	33.2
P6SMB27AQ	P6SMB27CAQ	25.65	28.35	1	1	23.1	16.0	37.5
P6SMB30AQ	P6SMB30CAQ	28.50	31.50	1	1	25.6	14.5	41.4
P6SMB33AQ	P6SMB33CAQ	31.35	34.65	1	1	28.2	13.1	45.7
P6SMB36AQ	P6SMB36CAQ	34.20	37.80	1	1	30.8	12.0	49.9
P6SMB39AQ	P6SMB39CAQ	37.05	40.95	1	1	33.3	11.1	53.9
P6SMB43AQ	P6SMB43CAQ	40.85	45.15	1	1	36.8	10.1	59.3
P6SMB47AQ	P6SMB47CAQ	44.65	49.35	1	1	40.2	9.3	64.8
P6SMB51AQ	P6SMB51CAQ	48.45	53.55	1	1	43.6	8.6	70.1
P6SMB56AQ	P6SMB56CAQ	53.20	58.80	1	1	47.8	7.8	77.0
P6SMB62AQ	P6SMB62CAQ	58.90	65.10	1	1	53.0	7.1	85.0
P6SMB68AQ	P6SMB68CAQ	64.60	71.40	1	1	58.1	6.5	92.0



## P6SMB12AQ THRU P6SMB220CAQ

### ■Electrical Characteristics (T<sub>a</sub>=25°C Unless otherwise specified)

Part Number (Uni)	Part Number (Bi)	Breakdown Voltage V <sub>BR</sub> @I <sub>T</sub>			Maximum Reverse Leakage I <sub>R</sub> <sup>(6)</sup> @ V <sub>RWM</sub> (μA)	Working Peak Reverse Voltage V <sub>RWM</sub> (V)	Maximum Reverse Surge Current I <sub>PP</sub> <sup>(5)</sup> (A)	Maximum Clamping Voltage V <sub>c</sub> @ I <sub>PP</sub> (V)
		Min(V)	Max (V)	I <sub>T</sub> <sup>(4)</sup> (mA)				
P6SMB75AQ	P6SMB75CAQ	71.25	78.75	1	1	64.1	5.8	103.0
P6SMB82AQ	P6SMB82CAQ	77.90	86.10	1	1	70.1	5.3	113.0
P6SMB91AQ	P6SMB91CAQ	86.45	95.35	1	1	77.8	4.8	125.0
P6SMB100AQ	P6SMB100CAQ	95.00	105.00	1	1	85.5	4.4	137.0
P6SMB110AQ	P6SMB110CAQ	104.50	115.50	1	1	94.0	4.0	152.0
P6SMB120AQ	P6SMB120CAQ	114.00	126.00	1	1	102.0	3.6	165.0
P6SMB130AQ	P6SMB130CAQ	123.50	136.50	1	1	111.0	3.4	179.0
P6SMB150AQ	P6SMB150CAQ	142.50	157.50	1	1	128.0	2.9	207.0
P6SMB160AQ	P6SMB160CAQ	152.00	168.00	1	1	136.0	2.7	219.0
P6SMB170AQ	P6SMB170CAQ	161.50	178.50	1	1	145.0	2.6	234.0
P6SMB180AQ	P6SMB180CAQ	171.00	189.00	1	1	154.0	2.4	246.0
P6SMB200AQ	P6SMB200CAQ	190.00	210.00	1	1	171.0	2.2	274.0
P6SMB220AQ	P6SMB220CAQ	209.00	231.00	1	1	185.0	1.8	328.0

Notes:

(4) Pulse test: t<sub>p</sub>≤50ms.

(5) Surge current waveform per Fig. 3 and derated per Fig.2.



# P6SMB12AQ THRU P6SMB220CAQ

## ■ Characteristics (Typical)

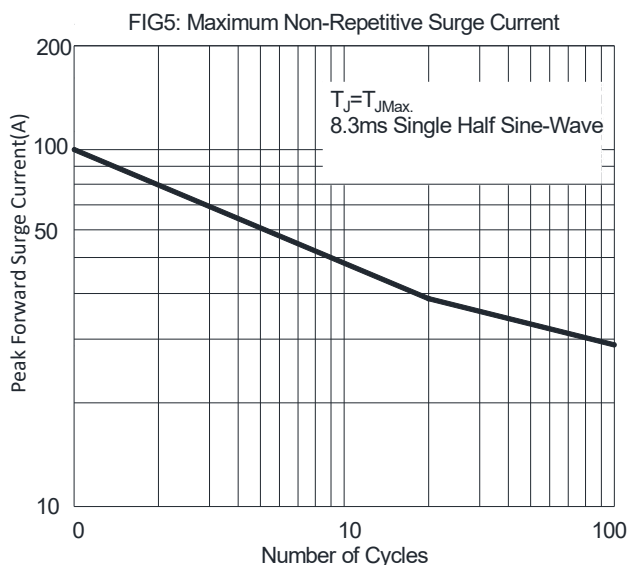
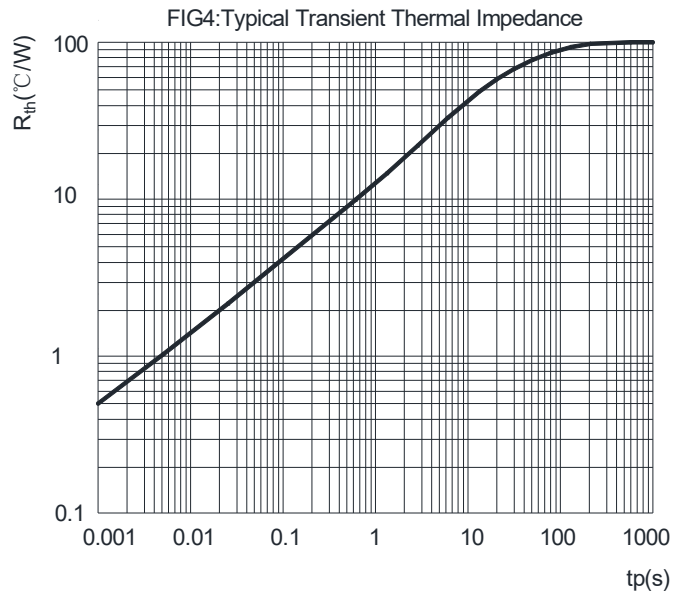
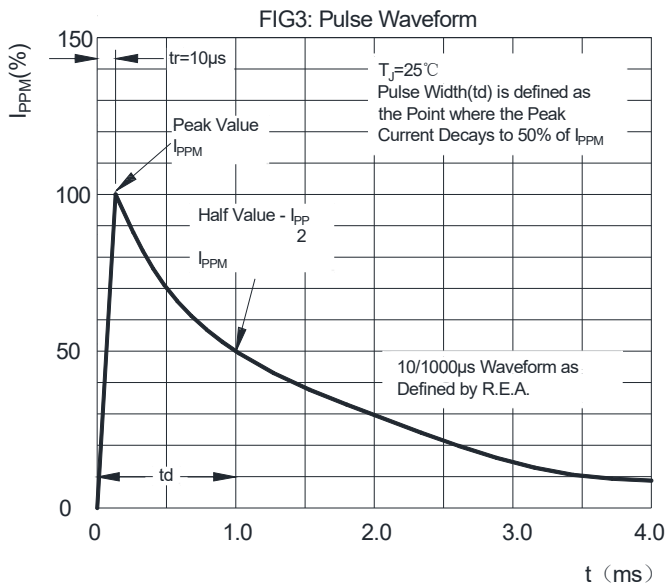
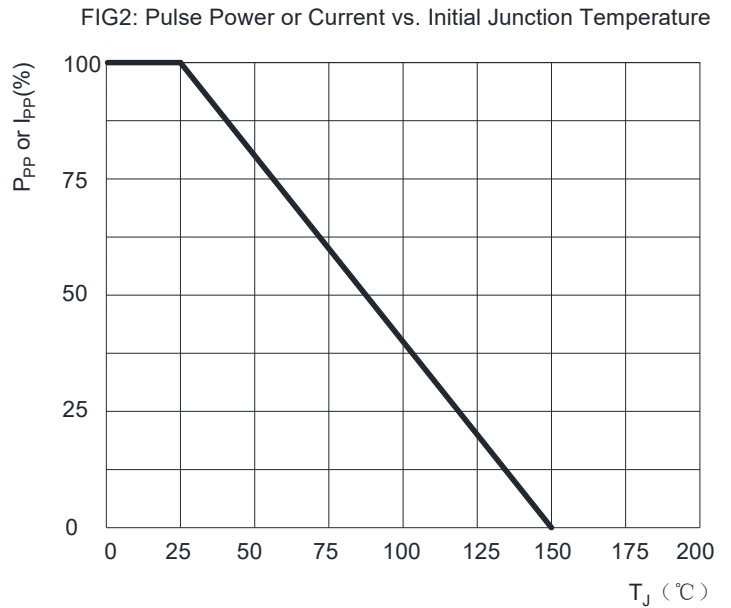
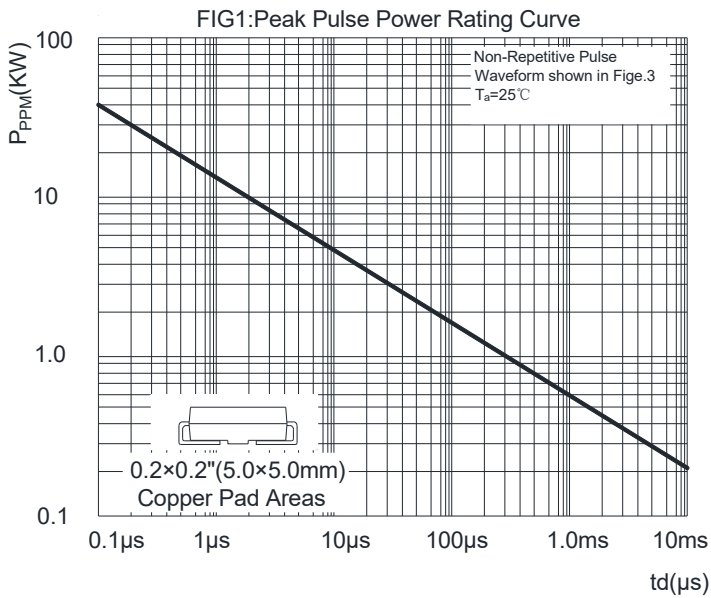



# P6SMB12AQ THRU P6SMB220CAQ

## ■ Outline Dimensions

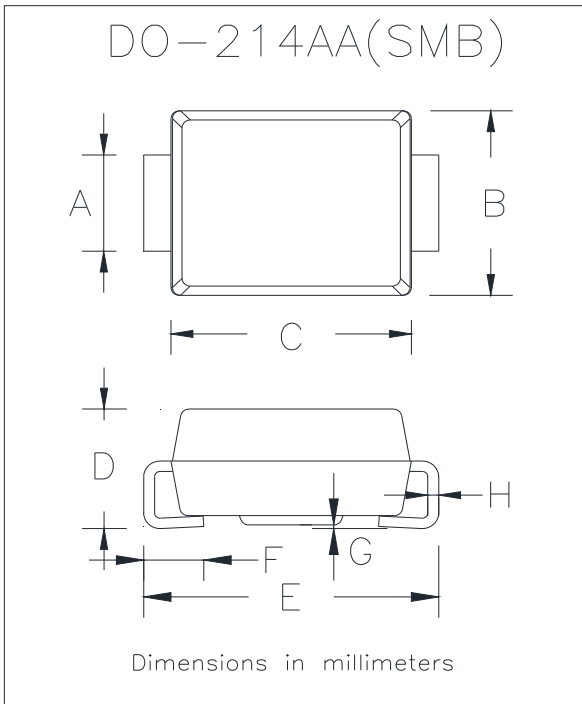

DO-214AA(SMB)		
Dim	Min	Max
A	1.85	2.15
B	3.30	3.94
C	4.05	4.75
D	1.99	2.61
E	5.21	5.59
F	0.90	1.41
G	0.10	0.20
H	0.15	0.31

## ■ Suggested pad layout

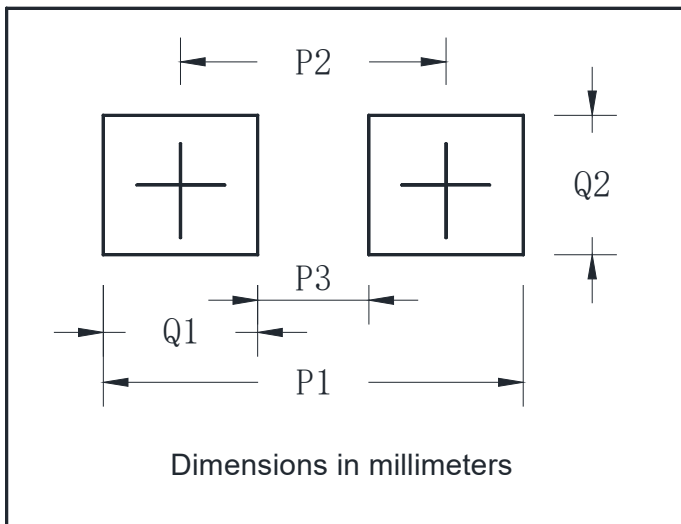

DO-214AA(SMB)	
Dim	Millimeters
P1	6.8
P2	4.3
P3	1.8
Q1	2.5
Q2	2.3



## P6SMB12AQ THRU P6SMB220CAQ

---

### Disclaimer

The information presented in this document is for reference only. Yangzhou Yangjie Electronic Technology Co., Ltd. reserves the right to make changes without notice for the specification of the products displayed herein to improve reliability, function or design or otherwise.

The product listed herein is designed to be used with automotive electronics, are not designed for use in medical, lifesaving, lifesustaining, or military, Yangjie or anyone on its behalf, assumes no responsibility or liability for any damages resulting from such improper use of sale.

This publication supersedes & replaces all information previously supplied. For additional information, please visit our website [http:// www.21yangjie.com](http://www.21yangjie.com) , or consult your nearest Yangjie's sales office for further assistance.